

# KENWOOD

**KDC-MP822**

**KDC-V7022**

**KDC-X769**

**KDC-722**

CD-RECEIVER

## INSTRUCTION MANUAL

KENWOOD CORPORATION



**Take the time to read through this instruction manual.**

**Familiarity with installation and operation procedures will help you obtain the best performance from your new CD-receiver.**

### **For your records**

Record the serial number, found on the back of the unit, in the spaces designated on the warranty card, and in the space provided below. Refer to the model and serial numbers whenever you call upon your KENWOOD dealer for information or service on the product.

Model KDC-MP822, KDC-V7022, KDC-X769, KDC-722 Serial number \_\_\_\_\_

© B64-2460-00/01(KV)

## Contents

<b>▲Warning</b> .....	<b>3</b>	<b>CD/MP3/External disc control features</b> .....	<b>23</b>	Dimmer	
<b>Safety precautions</b> .....	<b>4</b>	Playing CD & MP3		OFF Wait Time Setting	
<b>About Sirius Satellite radio tuner</b> .....	<b>5</b>	Playing External Disc		Eject angle setting	
<b>Notes on playing MP3</b> .....	<b>6</b>	Fast Forwarding and Reversing		System Q Setting	
<b>Notes on Multi-function Key System</b> .....	<b>8</b>	Track/File Search		Switching preout	
<b>About CDs</b> .....	<b>9</b>	Disc/ Folder Search		Built-in Amp Mute Setting	
<b>General features</b> .....	<b>10</b>	Direct Track/File Search		B.M.S. (Bass Management System)	
Power		Direct Disc Search		B.M.S. Frequency Offset	
Selecting the Source		Track/File/Disc/Folder Repeat		Sirius ID [ESN] display	
Volume		Scan Play		CRSC (Clean Reception System Circuit)	
Attenuator		Random Play		Text Scroll	
System Q		Magazine Random Play		Built-in Auxiliary input Setting	
Audio Control		Folder Select		CD Read Setting	
Speaker Setting		Text/Title Scroll			
Display Mode Switching		DNPP (Disc Name Preset Play)		<b>Basic Operations of remote</b> .....	<b>37</b>
Text Display Switching				<b>Accessories</b> .....	<b>39</b>
Illumination Color Setting		<b>Sirius tuner control features</b> .....	<b>28</b>	<b>Installation Procedure</b> .....	<b>39</b>
Station/Disc Naming (SNPS/DNPS)		Select Sirius Satellite Radio Mode		<b>Connecting Wires to Terminals</b> .....	<b>40</b>
Auxiliary Input Display Setting		Switching Seek Mode		<b>Installation</b> .....	<b>41</b>
Non-fading Output		Channel/Category Search		<b>Removing the Unit</b> .....	<b>42</b>
Panel Position Setting		Direct Access Search		<b>Locking the Backpanel to the unit</b> .....	<b>43</b>
Theft Deterrent Panel		Selecting the Preset Band		<b>Troubleshooting Guide</b> .....	<b>44</b>
Hiding the Control Panel		Channel Preset Memory		<b>Specifications</b> .....	<b>47</b>
Dual Zone System		Preset Tuning			
<b>Tuner features</b> .....	<b>21</b>	Channel Scan			
Tuning Mode		Text Scroll for Sirius tuner source			
Tuning		<b>Menu system</b> .....	<b>31</b>		
Direct Access Tuning		Menu System			
Station Preset Memory		Security Code			
Auto Memory Entry		Touch Sensor Tone			
Preset Tuning		Manual Clock Adjustment			
		DSI (Disabled System Indicator)			
		Selectable Illumination			
		Contrast Adjustment			

## **▲ Warning**

---

### **▲ CAUTION**

Use of controls or adjustments or performance of procedures other than those specified herein may result in hazardous radiation exposure.

In compliance with Federal Regulations, following are reproductions of labels on, or inside the product relating to laser product safety.

KENWOOD CORPORATION  
2967-3, ISHIKAWA-CHO,  
HACHIOJI-SHI  
TOKYO, JAPAN

KENWOOD CORP. CERTIFIES THIS EQUIPMENT  
CONFORMS TO DHHS REGULATIONS NO.21 CFR  
1040. 10, CHAPTER 1, SUBCHAPTER J.

Location : Bottom Panel

### **FCC WARNING**

This equipment may generate or use radio frequency energy. Changes or modifications to this equipment may cause harmful interference unless the modifications are expressly approved in the instruction manual. The user could lose the authority to operate this equipment if an unauthorized change or modification is made.

### **NOTE**

This equipment has been tested and found to comply with the limits for a Class B digital device, pursuant to Part 15 of the FCC Rules. These limits are designed to provide reasonable protection against harmful interference in a residential installation. This equipment may cause harmful interference to radio communications, if it is not installed and used in accordance with the instructions. However, there is no guarantee that interference will not occur in a particular installation. If this equipment does cause harmful interference to radio or television reception, which can be determined by turning the equipment off and on, the user is encouraged to try to correct the interference by one or more of the following measures:

- Reorient or relocate the receiving antenna.
- Increase the separation between the equipment and receiver.
- Connect the equipment into an outlet on a circuit different from that to which the receiver is connected.
- Consult the dealer or an experienced radio/TV technician for help.

### **NOTE**

This Class B digital apparatus complies with Canadian ICES-003.

## Safety precautions

### **▲WARNING**

#### **To prevent injury or fire, take the following precautions:**

- Insert the unit all the way in until it is fully locked in place. Otherwise it may fall out of place when jolted.
- When extending the ignition, battery, or ground wires, make sure to use automotive-grade wires or other wires with a 0.75mm<sup>2</sup> (AWG18) or more to prevent wire deterioration and damage to the wire coating.
- To prevent a short circuit, never put or leave any metallic objects (such as coins or metal tools) inside the unit.
- If the unit starts to emit smoke or strange smells, turn off the power immediately and consult your Kenwood dealer.
- Make sure not to get your fingers caught between the faceplate and the unit.
- Be careful not to drop the unit or subject it to strong shock.  
The unit may break or crack because it contains glass parts.
- Do not touch the liquid crystal fluid if the LCD is damaged or broken due to shock. The liquid crystal fluid may be dangerous to your health or even fatal.  
If the liquid crystal fluid from the LCD contacts your body or clothing, wash it off with soap immediately.

### **▲CAUTION**

#### **To prevent damage to the machine, take the following precautions:**

- Make sure to ground the unit to a negative 12V DC power supply.
- Do not open the top or bottom covers of the unit.
- Do not install the unit in a spot exposed to direct sunlight or excessive heat or humidity. Also avoid places with too much dust or the possibility of water splashing.
- Do not subject the faceplate to excessive shock, as it is a piece of precision equipment.
- When replacing a fuse, only use a new one with the prescribed rating. Using a fuse with the wrong rating may cause your unit to malfunction.
- To prevent a short circuit when replacing a fuse, first disconnect the wiring harness.
- Do not place any object between the faceplate and the unit.
- Do not use your own screws. Use only the screws provided. If you use the wrong screws, you could damage the unit.
- Do not apply excessive force to the moving faceplate. Doing so will cause damage or malfunction.
- Do not apply excessive force to the open faceplate or place objects on it. Doing so will cause damage or breakdown.

### **IMPORTANT INFORMATION**

#### **About CD players/disc changers connected to this unit**

KENWOOD disc changers/ CD players released in 1998 or later can be connected to this unit.

Refer to the catalog or consult your Kenwood dealer for connectable models of disc changers/ CD players.

Note that any KENWOOD disc changers/ CD players released in 1997 or earlier and disc changers made by other makers cannot be connected to this unit.

Unsupported connection may result in damage.

Setting the "O-N" Switch to the "N" position for the applicable KENWOOD disc changers/ CD players.

The functions that can be used and the information that can be displayed will differ depending on the models being connected.



You can damage both your unit and the CD changer if you connect them incorrectly.

#### **Do Not Load 3-in. CDs in the CD slot**

If you try to load a 3 in. CD with its adapter into the unit, the adapter might separate from the CD and damage the unit.

## About Sirius Satellite radio tuner

### NOTE

- If you experience problems during installation, consult your Kenwood dealer.
- If the unit fails to operate properly, press the Reset button. The unit returns to factory settings when the Reset button is pressed. If the unit still fails to operate properly after the Reset button has been pressed, contact your local KENWOOD dealer for assistance.
- Press the reset button if the disc auto changer fails to operate correctly. Normal operation should be restored.

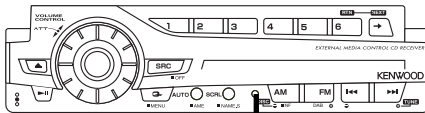

Reset button

- We recommend the use of <Security Code> (page 32) to prevent theft.
- Characters in the LCD may become difficult to read in temperatures below 41 °F (5 °C).
- The illustrations of the display and the panel appearing in this manual are examples used to explain more clearly how the controls are used. Therefore, what appears on the display in the illustrations may differ from what appears on the display on the actual equipment, and some of the illustrations on the display may represent something impossible in actual operation.

### Lens Fogging

Right after you turn on the car heater in cold weather, dew or condensation may form on the lens in the CD player of the unit. Called lens fogging, CDs may be impossible to play. In such a situation, remove the disc and wait for the condensation to evaporate. If the unit still does not operate normally after a while, consult your Kenwood dealer.

### Cleaning the Faceplate Terminals

If the terminals on the unit or faceplate get dirty, wipe them with a dry, soft cloth.

### Cleaning the Unit

If the faceplate of this unit is stained, wipe it with a dry soft cloth such as a silicon cloth. If the faceplate is stained badly, wipe the stain off with a cloth moistened with neutral cleaner, then wipe neutral detergent off.



Applying spray cleaner directly to the unit may affect its mechanical parts. Wiping the faceplate with a hard cloth or using a volatile liquid such as thinner or alcohol may scratch the surface or erases characters.

### Cleaning the CD Slot

As dust tends to accumulate in the CD slot, clean it every once in a while. Your CDs can get scratched if you put them in a dusty CD slot.

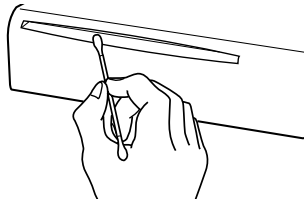

Refer to the Sirius tuner control features of this manual for the operation method of Sirius Satellite radio tuner KTC-SR901 (optional accessory) when connected.

## Notes on playing MP3 (KDC-MP822)

This unit can play MP3(MPEG1, 2, 2.5 Audio Layer 3). Note, however, that the MP3 recording media and formats acceptable are limited. When writing MP3, pay attention to the following restrictions.

### Acceptable media

The MP3 recording media acceptable to this unit are CD-ROM, CD-R, and CD-RW.

When using CD-RW, do full format not quick format to prevent malfunction.

### Acceptable medium formats

The following formats are available for the media used in this unit. The maximum number of characters used for file name including the delimiter (".") and three-character extension are indicated in parentheses.

- ISO 9660 Level 1 (12 characters)
- ISO 9660 Level 2 (31 characters)
- Joliet (64 characters)
- Romeo (128 characters)

Up to 200 characters can be displayed in the long file name format. For a list of available characters, see the instruction manual of the writing software and the section Entering file and folder names below. The media reproducible on this unit has the following limitations:

- Maximum number of directory levels: 8
- Maximum number of files per folder: 255
- Maximum number of characters for folder name: 64
- Maximum number of folders: 50

MP3 written in the formats other than the above may not be successfully played and their file names or folder names are not properly displayed.

### Settings for your MP3 encoder and CD writer

Do the following setting when compressing audio data in MP3 data with the MP3 encoder.

- Transfer bit rate: 8 —320 kbps
- Sampling frequency:  
8, 11.025, 12, 16, 22.05, 24, 32, 44.1, 48 kHz

When you use your CD writer to record MP3 up to the maximum disc capacity, disable additional writing. For recording on an empty disc up to the maximum capacity at once, check Disc at Once.

### Entering ID3 tag

The Displayable ID3 tag is ID3 version 1.x.

For the character code, refer to the List of Codes.

### Entering file and folder names

The code list characters are the only file names and folder names that can be entered and displayed.

If you use any other character for entry, the file and folder names are not displayed correctly. They may neither be displayed correctly depending on the CD writer used. The unit recognizes and plays only those MP3 which have the MP3 extension (.MP3).



A file with a name entered with characters not on the code list may not play correctly.

### Writing files into a medium

When a medium containing MP3 data is loaded, the unit checks all the data on the medium. If the medium contains a lot of folders or non-MP3 files, therefore, it takes a long time until the unit starts playing MP3.

In addition, it may take time for the unit to move to the next MP3 file or a File Search or Folder Search may not be performed smoothly.



Loading such a medium may produce loud noise to damage the speakers.

- Do no attempt to play a medium containing a non-MP3 file with the MP3 extension.  
The unit mistakes non-MP3 files for MP3 data as long as they have the MP3 extension.
- Do not attempt to play a medium containing non MP3.

0	1	2	3	4	5	6	7	8	9	A	B	C	D	E	F
		0	@	P	·	p				■	*	A	D	ä	d
1		1	1	A	O	a	q			i	±	A	N	ä	n
2		"	2	B	R	b	r			e	∇	A	O	ä	ö
3		#	3	C	S	c	s			£	∇	A	O	ä	ö
4		\$	4	D	T	d	t			©	∇	A	O	ä	ö
5		%	5	E	U	e	u			¥	∇	A	O	ä	ö
6		&	6	F	V	f	v			!	∇	A	O	ä	ö
7		'	7	G	W	g	w			§	·	C	X	C	±
8		(	8	H	X	h	x			∫	†	E	O	é	o
9		)	9	I	Y	i	y			©	†	E	U	é	u
A		*	J	Z	j	z				±	±	E	U	é	u
B		+	K	[	k	{				±	±	E	U	é	u
C		,	<	L	\					→	1/4	I	U	i	ü
D		-	=	M	]	}				⊗	1/2	I	Y	i	ÿ
E		.	>	N	^	~				⊗	3/4	I	P	i	p
F		/	?	O	_	o				~	∫	I	B	i	ÿ

## MP3 playing order

When selected for play, Folder Search, File Search, or for Folder Select, files and folders are accessed in the order in which they were written by the CD writer.

Because of this, the order in which they are expected to be played may not match the order in which they are actually played. You may be able to set the order in which MP3 are to be played by writing them onto a medium such as a CD-R with their file names beginning with play sequence numbers such as "01" to "99", depending on your CD writer.

For example, a medium with the following folder/ file hierarchy is subject to Folder Search, File Search, or Folder Select as shown below.

Example of a medium's folder/file hierarchy

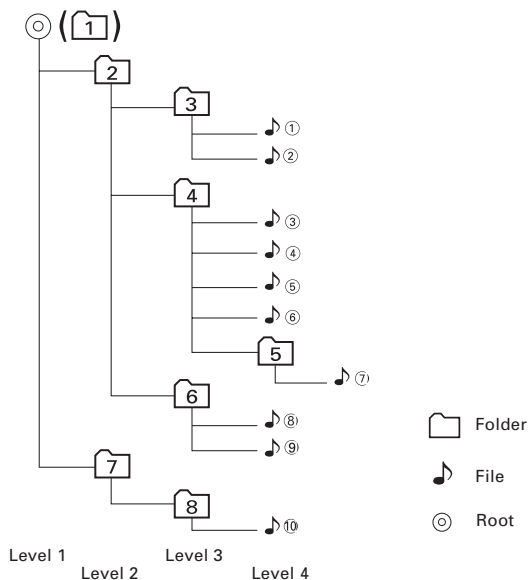

## When a File Search is executed with file 4 being played ...

Current file number	Operation of the button	
	◀◀ Button	▶▶ Button
4	Beginning of file 4 ▶ 3	5 ▶ 6

## When a Folder Search is executed with file 4 being played ...

Current folder number	Operation of the button	
	AM Button	FM Button
4	3 ▶ 2 ▶ 1 ▶ 8 ...	5 ▶ 6 ▶ 7 ▶ 8 ▶ 1 ...

## When Folder Select is selected with file 4 being played to move from folder to folder ...

Current folder number	Operation of the button			
	◀◀ Button	▶▶ Button	AM Button	FM Button
4	3	6	2	5

## Notes on Multi-function Key System

Multi-function Key System serves to control various functions with the [2] — [5] buttons.

The basic operation of the Multi-function Key System is described below.

### What's the Multi-function Key System?

This unit is equipped with the Multi-function Key System that enables the operation of multiple functions with one button.

For example, you can enter the Display Control Mode or turn ON/OFF the Random Play by pressing the [3] button during CD play.

### Setting each function

The function display will show the controllable function of the [2] — [5] button above the button.

Pressing the [2] — [5] button below the desired function enables the setting of the function.

### Displaying the desired function

If five or more functions are available to be set with the [2] — [5] button, they are divided into multiple function groups (referred to as sections in this manual) for registration.

Press the [NEXT] button to switch the sections.

If the display of the desired function is not shown, press the [NEXT] button 1 to 3 times to switch the sections until the wanted function display is shown.

Example: Function display of CD & External disc source

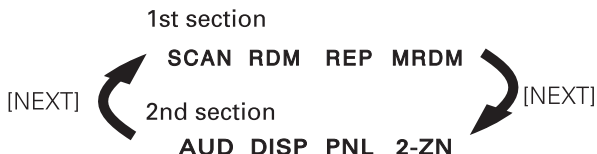

 \*MRDM\* are displayed when an optional accessory is connected.

### Real operational example of the Multi-function Key System

Example: Turning ON/OFF the Random Play during CD play.

1. Show the function display of the Random Play.

If "RDM" is not shown in the display, press the [NEXT] button to switch the sections until the "RDM" function display is shown above the [3] button.

2. Turn ON/OFF the Random Play.

Press the [3] button.

Each time the [3] button under the "RDM" function display is pressed the Random Play is turned ON/OFF.

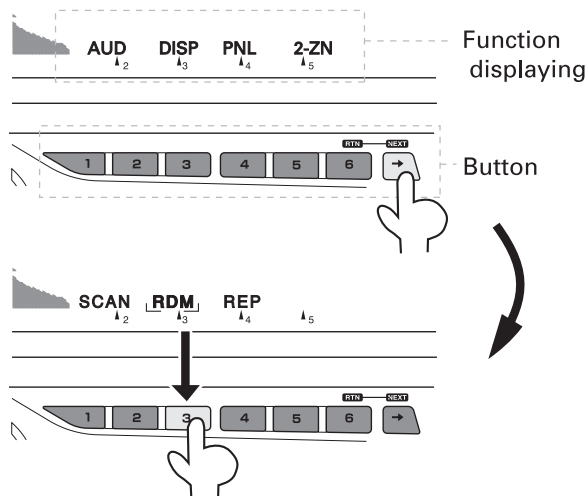



## About CDs

### Handling CDs

- Don't touch the recording surface of the CD.

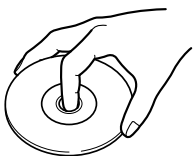

- CD-R and CD-RW are easier to damage than a normal music CD. Use a CD-R or a CD-RW after reading the caution items on the package etc.
- Don't stick tape etc. on the CD. Also, don't use a CD with tape stuck on it.

### When using a new CD

If the CD center hole or outside rim has burrs, use it after removing them with a ball pen etc.

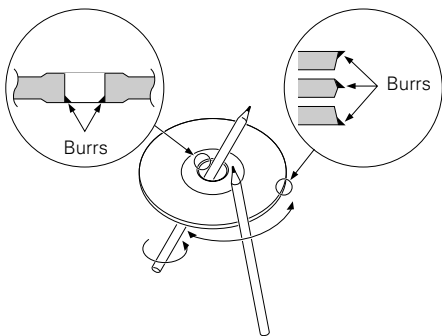

### CD accessories

Don't use disc type accessories.

### CD cleaning

Clean from the center of the disc and move outward.

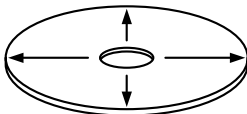



### Removing CDs

When removing CDs from this unit pull them out horizontally.

### CDs that can't be used

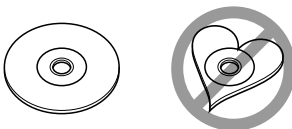
- CDs that aren't round can't be used.



- CDs with coloring on the recording surface or that are dirty can't be used.
- This unit can only play the CDs with  .

It may not correctly play disks which do not have the mark.

- A CD-R or CD-RW that hasn't been finalized can't be played. (For the finalization process refer to your CD-R/CD-RW writing software, and your CD-R/CD-RW recorder instruction manual.)

### CD storage

- Don't place them in direct sunlight (On the seat or dashboard etc.) and where the temperature is high.
- Store CDs in their cases.



## Volume

### **Increasing Volume**

Turn the [VOLUME CONTROL] knob clockwise.

### **Decreasing Volume**

Turn the [VOLUME CONTROL] knob counterclockwise.

## Attenuator

Turning the volume down quickly.

Press the [ATT] button.

Each time the button is pressed the Attenuator turns ON or OFF.

When it's ON, the "ATT" indicator blinks.

## System Q

You can recall the best sound setting preset for different types of music.

### **1 Select the source to set**

Press the [SRC] button.

### **2 Select the Sound type**

Press the [Q] button.

Each time the button is pressed the sound setting switches.

<b>Sound setting</b>	<b>Display</b>
Flat	"Flat"
User memory	"User"
Rock	"Rock"
Pops	"Pops"
Easy	"Easy"
Top 40	"Top40"
Jazz	"Jazz"



- User memory: The values set on the <Audio control> (page 12).
- Each setting value is changed with the <Speaker setting> (page 14).  
First, select the speaker type with the Speaker setting.

## General features

### Audio Control

#### 1 Select the source for adjustment

Press the [SRC] button.

#### 2 Select the key function section

Press the [NEXT] button.

Repeatedly press the button until "AUD" is displayed above the [2] button.

Refer to <Notes on Multi-function Key System> (page 8).

#### 3 Enter Audio Control mode

Press the [2] ("AUD") button.

#### 4 Select the Adjustment item section

Press the [NEXT] button.

Repeatedly press the button until the desired Adjustment item is displayed above the [2] — [5] button.

#### 1st section

Adjustment Item	Button	Display
Bass	[2]	"BASS"
Middle	[3]	"MID"
Treble	[4]	"TRE"
Balance & Fader	[5]	"BL/F"

#### 2nd section

Adjustment Item	Button	Display
High Pass Filter	[2]	"HPF"
Low Pass Filter*	[3]	"LPF"
Loudness	[4]	"LOUD"
Non-Fading*	[5]	"N-F"

#### 3rd section

Adjustment Item	Button	Display
Volume offset	[2]	"VOFF"

#### 5 Select the Audio Control item for adjustment

Press the [2] — [5] button.

Each time the [2] — [5] button is pressed the adjustable audio items are switched among ranges of all stage section's tables on the following pages.

#### 6 Adjust the Audio Control item

Press the [◀◀] or [▶▶] button.

Each time the button is pressed the setting switches as shown below.

#### 7 Exit Audio Control mode

Press the [RTN] button.



- The loudness setting can also be adjusted by pressing the [4] button.
- \*This mode is available only when <Non-fading Output> (page 17) is ON.

#### 1st section

##### [2] button

Adjustment Item	Display	Range
Bass Center Frequency**	"Bass F"	60/70/80/100 or 150 Hz
Bass level	"Bass"	-8 — +8
Bass Q Factor**	"Bass Q"	1.00/1.25/1.50/2.00
Bass Extend**	"Bass EXT"	ON/OFF

##### [3] button

Adjustment Item	Display	Range
Middle Center Frequency**	"MID F"	0.5/1.0/1.5/2.0 kHz
Middle level	"Middle"	-8 — +8
Middle Q Factor**	"Middle Q"	1.0/2.0

#### [4] button

Adjustment Item	Display	Range
Treble Center Frequency**	"TRE F"	10.0/12.5/15.0/17.5 kHz
Treble level	"Treble"	-8 — +8

#### [5] button

Adjustment Item	Display	Range
Balance	"Balance"	Left 15 — Right 15
Fader	"Fader"	Rear 15 — Front 15



- According to the Bass Q Factor setting value, the frequencies that can be set in Bass Center Frequency change as shown below.

Bass Q Factor	Bass Center Frequency
1.00/1.25/1.50	60/70/80/100
2.00	60/70/80/150

- When the bass extend is set to ON, low frequency response is extended by 20%.
- \*\* Function of the KDC-X769

### 2nd section

#### [2] button

Adjustment Item	Display	Range
Front High Pass Filter**"HPF F"	"HPF F"	Through/100/125/170 Hz
Rear High Pass Filter** "HPF R"	"HPF R"	Through/200 Hz
Front/Rear High Pass Filter	"HPF"	Through/100/125/170 Hz

#### [3] button

Adjustment Item	Display	Range
Non-Fading Low Pass Filter	"LPF NF"	50/80/120/Through Hz

#### [4] button

Adjustment Item	Display	Range
Loudness	"LOUD"	ON/OFF

#### [5] button

Adjustment Item	Display	Range
Non-Fading level	"NF Level"	-15 — +15



- Loudness: Compensating for low and high tones during low volume.
- When the Dual Zone System is ON, the setting for the High Pass Filter is nullified.
- \*\* Function of the KDC-X769

### 3rd section

#### [2] button

Adjustment Item	Display	Range
Volume offset	"V-Offset"	-8 — ±0



- Volume offset: Each source's volume can be set as a difference from the basic volume.

## General features

### Speaker Setting

Fine-tuning so that the System Q value is optimal when setting the speaker type.

#### 1 Enter Standby

Press the [SRC] button.  
Select the "ALL OFF" display.

#### 2 Enter Speaker Setting mode

Press the [Q] button.

#### 3 Select the Speaker type

Press the [2] — [5] button.  
Each time the button is pressed the setting switches as shown below.

Speaker type	Button	Display
OFF	[2]	"SP OFF"
For 5 & 4 in. speaker	[3]	"SP 5/4inch"
For 6 & 6x9 in. speaker	[4]	"SP 6*9/6inch"
For the OEM speaker	[5]	"SP O.E.M."

#### 4 Exit Speaker Setting mode

Press the [Q] button.

### Display Mode Switching

Switching the display mode.

#### 1 Select the key function section

Press the [NEXT] button.  
Repeatedly press the button until "DISP" is displayed above the [3] button.  
Refer to <Notes on Multi-function Key System> (page 8).

#### 2 Enter display control mode

Press the [3] ("DISP") button.

#### 3 Select the display mode

Press the [2] ("MODE") button.  
Each time the button is pressed the display mode switches as shown below.

Display	Display Mode
"Display C"	Demonstration.
"Display A"	Normal display type
"Display B"	Silent display type.

#### 4 Exit display control mode

Press the [RTN] button.

### Text Display Switching

Switching the text display.

#### 1 Select the key function section

Press the [NEXT] button.  
Repeatedly press the button until "DISP" is displayed above the [3] button.  
Refer to <Notes on Multi-function Key System> (page 8).

#### 2 Enter display control mode

Press the [3] ("DISP") button.

#### 3 Select the text

Press the [3] ("TEXT") button.



It can also be switched by pressing either [◀◀] or [▶▶] button.

### ***In Tuner source***

<b>Information</b>	<b>Display</b>
Station name or Frequency	"BAND+SNPS"
Frequency	"BAND+FREQ"
Clock	"Clock"

### ***In CD & External disc source***

<b>Information</b>	<b>Display</b>
Disc title	"D-TITLE"
Track title	"T-TITLE"
Track number & Play time	"P-Time"
Disc name	"DNPS"
Clock	"Clock"

### ***In MP3 source***

<b>Information</b>	<b>Display</b>
Song title & Artist name	"TITLE"
Album name & Artist name	"ALBUM"
Folder name	"FOLDER NAME"
File name	"FILE NAME"
Play time & File number	"P-Time"
Disc name	"DNPS"
Clock	"Clock"

### ***In Auxiliary input source***

<b>Information</b>	<b>Display</b>
Auxiliary input name	"AUX Name"
Clock	"Clock"

### ***In Standby***

<b>Information</b>	<b>Display</b>
	"ALL OFF"
Clock	"Clock"

### ***In Sirius tuner source***

<b>Information</b>	<b>Display</b>
Channel Name	"Channel Name"
Song Title	"Song Title"
Artist Name	"Artist Name"
Composer Name	"Composer"
Category Name	"Category"
Band & Channel Number	"Channel No"
Clock	"Clock"

## **4 Exit Display Control mode**

Press the [RTN] button.



- If the Disc title, Track title, Song title & Artist name, or Album name & Artist name is selected when the disc which does not have Disc title, Track title, Song title, Album name, or Artist name is played, track number and play time are displayed.
- If the text for the Sirius tuner source, including Channel name, etc. is selected when the channel which does not have text for the Sirius tuner source, including Channel name, etc. is played, band & channel number is displayed.

## General features

Function of the KDC-V7022

### Illumination Color Setting

You can set the display to a desired color.

#### 1 Select the key function section

Press the [NEXT] button.

Repeatedly press the button until "DISP" is displayed above the [3] button.

Refer to <Notes on Multi-function Key System> (page 8).

#### 2 Enter display control mode

Press the [3] ("DISP") button.

#### 3 Quick call up the preset color

Press the [4] ("CLR") button.

Each time the button is pressed the Color mode switches as shown below.

Color mode	Display
The color changes in sequence.	"COL Scan"
Preset color (Silky White)	"COL S.White"
Preset color (Red)	"COL Red"
Preset color (Blue)	"COL Blue"
Preset color (Blue Green)	"COL B.Green"
Original color	"COL User"
The color changes according to the selected source.	"COL SRC"
The color changes every 6 hours.	"COL Time"

#### The color continues to change gradually

Hold down on the [◀◀] or [▶▶] button.

"COL User" is displayed.

Release your finger at the color you want.

#### 4 Exit display control mode

Press the [RTN] button.

### Station/Disc Naming (SNPS/DNPS)

Attaching a title to a Station or CD.

#### 1 Receive/play the station/disc you want to attach a title to



- A title can't be attached to a MD.
- Refer to the <Text Display Switching> (page 14) and select either "DNPS" or "SNPS".

#### 2 Enter name set mode

Press the [NAME.S] button for at least 2 seconds.

"NAME SET" is displayed.

#### 3 Move the cursor to the enter character position

Press the [◀◀] or [▶▶] button.

#### 4 Select the character type

Press the [2] — [4] button.

Each time the button is pressed the character type switches as shown below.

Character type	Button
Alphabet (Upper case/ Lower case)	[2] ("CAPS")
Numbers and symbols	[3] ("NUM")
Special characters (Accent characters)	[4] ("CHAR")

#### 5 Select the characters

Press the [FM] or [AM] button.



Characters can be entered by using a remote with a number buttons.

Example: If "DANCE" is entered.

Character	Button	Times pressed
"D"	[3]	1
"A"	[2]	1
"N"	[6]	2
"C"	[2]	3
"E"	[3]	2

#### 6 Repeat steps 3 through 5 and enter the name.



## 7 Exit name set mode

Press the [NAME.S] button.



- When operation stops for 10 seconds the name at that time is registered, and Name Set mode closes.
- Memory numbers
  - FM: 32 stations
  - AM: 16 stations
  - Internal CD player: 30 discs
  - External CD changer/ player: Varies according to the CD changer/ player. Refer to the CD changer/ player manual.
- The title of station/CD can be changed by the same operation used to name it.

## Auxiliary Input Display Setting

Selecting the display when this device is switched to Auxiliary input source.

### 1 Select Auxiliary input source

Press the [SRC] button.

Select the "AUX"/"AUX1" display.

### 2 Enter Auxiliary input display setting mode

Press the [NAME.S] button for at least 2 seconds.

The presently selected AUX Name is blinks.

### 3 Select the Auxiliary input display

Press the [◀◀] or [▶▶] button.

Each time the button is pressed it switches through the below displays.

- "AUX"/"AUX1"
- "TV"
- "VIDEO"
- "GAME"
- "PORTABLE"
- "DVD"

## 4 Exit Auxiliary input display setting mode

Press the [NAME.S] button.



- When operation stops for 10 seconds, the name at that time is selected, and Auxiliary input display setting mode closes.

## Non-fading Output

Turning the Non-fading output ON or OFF.

Press the [NF] button for at least 1 second.

Each time the button is pressed Non-fading output switches ON or OFF.

When it's ON, "NF ON" is displayed.



- When the <Switching preout> (page 34) is "SWPRE Rear", this function is not available. (KDC-V7022/722 only)

## General features

### Panel Position Setting

Setting the angle or back-forward position of the control panel.

#### 1 Select the key function section

Press the [NEXT] button.

Repeatedly press the button until "PNL" is displayed above the [4] button.

#### 2 Enter Panel Position Setting mode

Press the [4] ("PNL") button.

#### 3 Select the item for adjustment

Press the desired [2] — [5] button.

Each time the button is pressed the items that can be adjusted switch as shown below.

Adjustment Item	Button	Display
The panel tilts upwards	[2]	"ANG-"
The panel tilts downwards	[3]	"ANG+"
The panel slides backward	[4]	"SLD-"
The panel slides forward	[5]	"SLD+"

#### 4 Exit Panel Position Setting mode

Press the [RTN] button.

 The control panel may be interfered with the shift lever or another part depending on the angles of the control panel. Set the angle to avoid any interference.

 No sound is produced while the panel is operating.

### Theft Deterrent Panel

The Backpanel of the unit can be detached and taken with you, helping to deter theft.

#### Removing the Backpanel

1 Turn the ignition OFF or press the [SRC] button for at least 1 second.

Turn OFF the power, and the control panel becomes horizontal.

 After the set time passes in <OFF Wait Time Setting> (page 34), the panel is closed.

2 Remove the Backpanel forward.

When <DSI (Disabled System Indicator)> (page 33) is set to ON, DSI blinks.

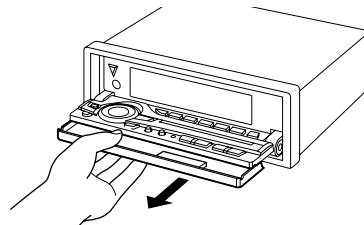

-  The back panel is a precision piece of equipment and can be damaged by shocks or jolts. For that reason, keep the back panel in its special storage case while detached.
- Do not expose the Backpanel or its storage case to direct sunlight or excessive heat or humidity. Also avoid places with too much dust or the possibility of water splashing.

#### Reattaching the Backpanel

1 Set the Backpanel to the panel bracket.

2 Hold down on the Backpanel until it is locked.

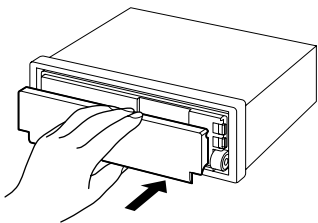

### **Hiding the Control Panel**

Prevents tampering with the unit while your car is being serviced etc.

#### ***Hiding the control panel***

Press the [SRC] button for at least 1 second.

When the time set in <OFF Wait Time Setting> (page 34) lapses, the panel is hidden and the power turns OFF.

#### ***Showing the control panel***

Press the left part at the lower side of the panel.

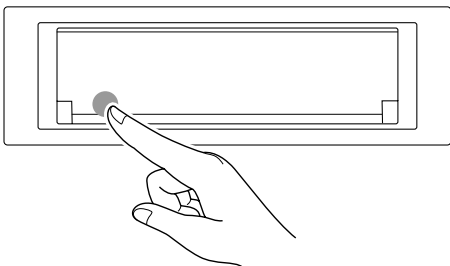

The panel is opened to enable the operation.

## General features

Function of the KDC-V7022/KDC-X769

### Dual Zone System <In Sirius Tuner, External disc, or Auxiliary input source>

Makes the sound different for the front channel and rear channel.

#### 1 Select the source

Press the [SRC] button.

Select the source sound to be output from the Dual zone channel.

#### 2 Select the key function section

Press the [NEXT] button.

Repeatedly press the button until "2-ZN" is displayed above the [5] button.

Refer to <Notes on Multi-function Key System> (page 8).

#### 3 Enter the Dual Zone System Control mode

Press the [5] ("2-ZN") button.

#### 4 Select the item for adjustment

Press the desired [2] — [3] button.

Each time the button is pressed the items that can be adjusted switch as shown below.

Adjustment Item	Button	Display	Range
Dual Zone System	[2]	"ON"/"OFF"	ON/OFF
Dual Zone System Front & Rear	[3]	"F—R"	Front/Rear



Dual Zone System Rear: The sound of the source selected with step 1 is outputted from rear, and the sound of the source selected with step 6 is outputted from front.

Dual Zone System Front: The sound of the source selected with step 1 is outputted from front, and the sound of the source selected with step 6 is outputted from rear.

#### 5 Exit the Dual Zone System Control mode

Press the [RTN] button.

#### 6 Select the source

Press the [SRC] button.

Select the source sound to be output from the internal source channel.



- The Dual Zone System can be used with the sources shown below.
  - Internal auxiliary input
  - KCA-S210A
  - CA-C1AX
  - External disc changer/ player
  - Sirius satellite radio tuner
- While Dual Zone System is ON, the setting of Dual Zone System Front or Rear is disabled. Set Dual Zone System Front or Rear first, and then set the Dual Zone System to ON.
- When the Dual Zone System is ON, there is no Dual zone channel audio control or other effect.
- When you use the Dual Zone System by selecting the optional accessory source for the output of the Dual zone channel, you cannot select another optional accessory source as the source for the Internal source channel.
- When you set the Dual zone system to ON while the non-fading preout is switched ON, the sound of the non-fading preout isn't output.
- When the Dual Zone System is ON, the setting for the High Pass Filter is nullified.

## Tuner features

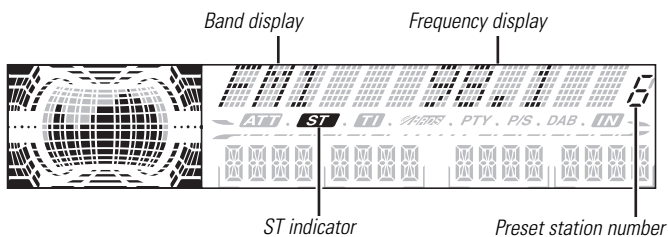
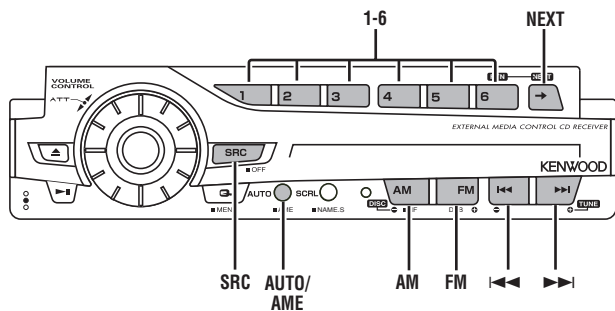

### Tuning Mode

Choose the tuning mode.

Press the [AUTO] button.

Each time the button is pressed the Tuning mode switches as shown below.

Tuning mode	Display	Operation
Auto seek	"Auto 1"	Automatic search for a station.
Preset station seek	"Auto 2"	Search in order of the stations in the Preset memory.
Manual	"Manual"	Normal manual tuning control.

### Tuning

Selecting the station.

#### 1 Select tuner source

Press the [SRC] button.

Select the "TUNER" display.

#### 2 Select the band

Press the [FM] or [AM] button.

Each time the [FM] button is pressed it switches between the FM1, FM2, and FM3 bands.

#### 3 Tune up or down band

Press the [◀◀] or [▶▶] button.



During reception of stereo stations the "ST" indicator is ON.

## Tuner features

### Direct Access Tuning (Function of remote)

Entering the frequency and tuning.

#### 1 Select the band

Press the [FM] or [AM] button.

#### 2 Enter Direct Access Tuning mode

Press the [DIRECT] button on the remote.

"----" is displayed.

#### 3 Enter the frequency

Press the number buttons on the remote.

Example:

Desired frequency	Press button
92.1 MHz (FM)	[0], [9], [2], [1]
810 kHz (AM)	[0], [8], [1], [0]

### Canceling Direct Access Tuning

Press the [DIRECT] button on the remote.

### Station Preset Memory

Putting the station in the memory.

#### 1 Select the band

Press the [FM] or [AM] button.

#### 2 Select the frequency to put in the memory

Press the [◀◀] or [▶▶] button.

#### 3 Select the key function section

Press the [NEXT] button.

Repeatedly press the button until the function item is not displayed above the [2] — [5] button.

Refer to <Notes on Multi-function Key System> (page 8).

#### 4 Put the frequency in the memory

Press the desired [1] — [6] button for at least 2 seconds.

The preset number display blinks 1 time.

On each band, 1 station can be put in the memory on each [1] — [6] button.

### Auto Memory Entry

Putting stations with good reception in the memory automatically.

#### 1 Select the band for Auto Memory Entry

Press the [FM] or [AM] button.

#### 2 Open Auto Memory Entry

Press the [AME] button for at least 2 seconds.

When 6 stations that can be received are put in the memory Auto Memory Entry closes.

### Preset Tuning

Calling up the stations in the memory.

#### 1 Select the band

Press the [FM] or [AM] button.

#### 2 Select the key function section

Press the [NEXT] button.

Repeatedly press the button until the function item is not displayed above the [2] — [5] button.

Refer to <Notes on Multi-function Key System> (page 8).

#### 3 Call up the station

Press the desired [1] — [6] button.

## CD/MP3/External disc control features

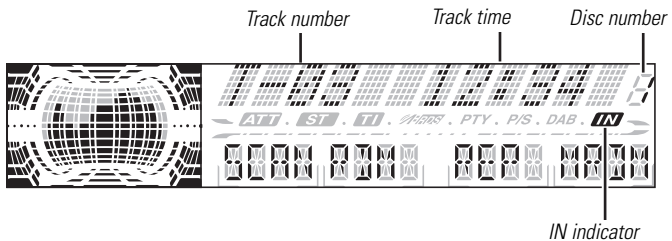
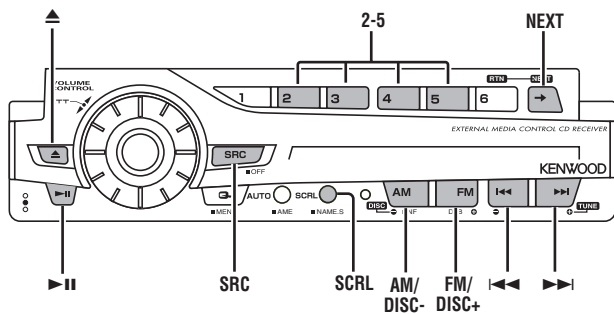

## CD/MP3/External disc control features

### Playing CD & MP3

#### When there is no disc inserted

##### 1 Open the panel to insert disc

Press the [▲] button.

##### 2 Insert a disc.



When the faceplate has been slid open, it might interfere with the shift lever or something else. If this happens, pay attention to safety and move the shift lever or take an appropriate action, then operate the unit.



- The sound will be temporarily muted while the faceplate is moving.
- The models that can play MP3 are shown below.  
KDC-MP822
- When a disc is inserted the "IN" indicator is ON.

#### When a disc is inserted

Press the [SRC] button.

Select the "CD" display.

#### Pause and play

Press the [▶II] button.

Each time the button is pressed the song pauses or plays.

#### Eject the disc

##### 1 Eject the disc

Press the [▲] button.

##### 2 Return the panel to the original position

Press the [▲] button.



3 in. (8cm) disc can't be played. Using an adapter and inserting them into this unit can cause damage.



The MP3 media that this unit can play are CD-ROM, CD-R, and CD-RW.

The medium formats must be ISO 9660 Level 1, Level 2, Joliet, or Romeo. The methods and precautions to be followed for writing MP3 data are covered in <Notes on playing MP3> (page 6). Check

that section before creating your MP3 media.

### Playing External Disc

Playing discs set in the optional accessory disc player connected to this unit.

Press the [SRC] button.

Select the display for the disc player you want.

Display examples:

Display	Disc player
"CD2"	CD player
"DISC CH"	CD changer/MD changer

#### Pause and play

Press the [▶II] button.

Each time the button is pressed it pauses and plays.



- Disc 10 is displayed as "0".
- The functions that can be used and the information that can be displayed will differ depending on the external disc players being connected.

### Fast Forwarding and Reversing

#### Fast Forwarding

Hold down on the [▶▶] button.

Release your finger to play the disc at that point.

#### Reversing

Hold down on the [◀◀] button.

Release your finger to play the disc at that point.



## Track/File Search

Searching for a song on the disc or in the MP3 folder.

Press the [◀◀] or [▶▶] button.

## Disc/ Folder Search

(Disc Search: Function of disc changer)  
(Folder Search: Function of MP3)

Selecting the disc set in the Disc changer or the folder recorded on the MP3 media.

Press the [DISC-] or [DISC+] button.

## Direct Track/File Search (Function of remote) (Direct File Search: Function of MP3)

Doing Track/File Search by entering the track/file number.

### 1 Enter the track/file number

Press the number buttons on the remote.

### 2 Do Track/File Search

Press the [◀◀] or [▶▶] button.

### Canceling Direct Track/File Search

Press the [▶||] button.

## Direct Disc Search (Function of disc changers with remote)

Doing Disc Search by entering the disc number.

### 1 Enter the disc number

Press the number buttons on the remote.

### 2 Do Disc Search

Press the [DISC+] or [DISC-] button.

### Canceling Direct Disc Search

Press the [▶||] button.



Input "0" to select disc 10.

## CD/MP3/External disc control features

### Track/File/Disc/Folder Repeat

Replaying the song, disc in the Disc changer or MP3 folder you're listening to.

#### 1 Select the key function section

Press the [NEXT] button.

Repeatedly press the button until "REP" is displayed above the [4] button.

Refer to <Notes on Multi-function Key System> (page 8).

#### 2 Turn ON/OFF the Repeat Play

Press the [4] ("REP") button.

Each time the button is pressed the Repeat Play switches as shown below.

#### In CD & External disc source

Repeat play	Display
Track Repeat	"Repeat ON/ "T-Repeat ON"
Disc Repeat (In Disc Changer)	"D-Repeat ON"
OFF	"Repeat OFF"

#### In MP3 source

Repeat play	Display
File Repeat	"File REP ON"
Folder Repeat	"FOLD REP ON"
OFF	"Repeat OFF"

### Scan Play

Playing the first part of each song on the disc or MP3 folder you are listening to and searching for the song you want to listen to.

#### 1 Select the key function section

Press the [NEXT] button.

Repeat to press the button until "SCAN" is displayed above the [2] button.

#### 2 Start Scan Play

Press the [2] ("SCAN") button.

"Scan ON" is displayed.

#### 3 Release it when the song you want to listen to is played

Press the [2] button.

### Random Play

Play all the songs on the disc or MP3 folder in random order.

#### 1 Select the key function section

Press the [NEXT] button.

Repeatedly press the button until "RDM" is displayed above the [3] button.

#### 2 Turn ON/OFF the Random Play

Press the [3] ("RDM") button.

Each time the button is pressed Random Play turns ON or OFF. When it's ON, "Random ON" is displayed.



When the [▶▶] button is pressed, the next song select starts.

### Magazine Random Play

(Function of disc changer)

Play the songs on all the discs in the disc changer in random order.

#### 1 Select the key function section

Press the [NEXT] button.

Repeatedly press the button until "MRDM" is displayed above the [5] button.

## 2 Turning ON/OFF the Magazine Random Play

Press the [5] ("MRDM") button.

Each time the button is pressed the Magazine Random Play turns ON or OFF.

When it's ON, "M-Random ON" is displayed.

 When the [▶▶] button is pressed, the next song select starts.

### Function of the KDC-MP822

#### Folder Select

#### (Function of MP3)

Quickly selecting the folder you want to listen to.

### 1 Select the key function section

Press the [NEXT] button.

Repeatedly press the button until "FSEL" is displayed above the [5] button.

Refer to <Notes on Multi-function Key System> (page 8).

### 2 Enter Folder Select mode

Press the [5] ("FSEL") button.

"Select Mode" is displayed.

During Select mode the folder information is displayed as shown below.

<Folder name display>

Displays the current folder name.

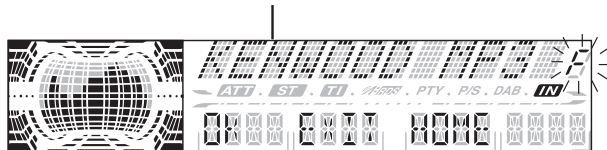

### 3 Select the folder level

Press the [FM] or [AM] button.

With the [FM] button you move 1 level down and with the [AM] button 1 level up.

#### Selecting a folder in the same level

Press the [◀◀] or [▶▶] button.

With the [◀◀] button you move to the previous folder, and with the [▶▶] button to the next folder.

#### Returning to the top level

Press the [4] ("HOME") button.

#### Scrolling the folder name display

Press the [SCRL] button.

### 4 Decide the folder to play

Press the [2] ("OK") button.

The Folder Select mode releases, and the MP3 in the folder being displayed is played.

 The methods for moving to other folders in the folder select mode are different from those in the folder search mode. See <Notes on playing MP3> (page 6) for details.

#### Canceling the Folder Select mode

Press the [3] ("EXIT") button.

#### Text/Title Scroll

Scrolling the displayed CD text, MP3 text, or MD title.

Press the [SCRL] button.

## CD/MP3/External disc control features

### DNPP (Disc Name Preset Play) (Function of disc changers with remote)

Selecting the CD displayed in the DNPS of the CDs set in the Disc changer.

#### 1 Enter DNPP mode

Press the [DNPP] button on the remote.

When "DNPP" is displayed the DNPS display in order.

#### Forward / Reverse display

Press the [DISC-] or [DISC+] button.

#### 2 When the disc you want is displayed

Press the [OK] button on the remote.

The disc being displayed is played.

#### Canceling the DNPP mode

Press the [DNPP] button on the remote.

## Sirius tuner control features

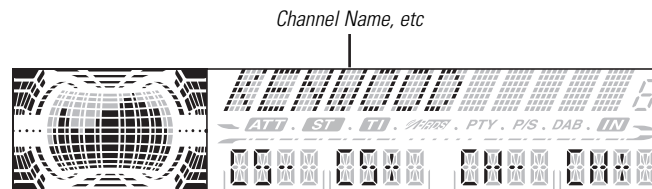
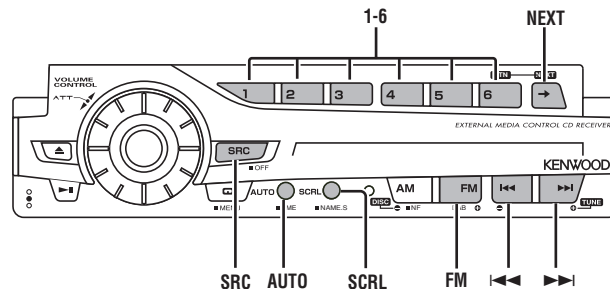

## Select Sirius Satellite Radio Mode

Selecting the Sirius Satellite Radio Tuner (optional accessory) connected to this unit.

### Selecting Sirius Mode

Press the [SRC] button.

Select the "SIRIUS" display.



- You need to subscribe to SIRIUS to receive the service by Sirius Satellite Radio. Consult SIRIUS if "CALL 888-539 SIRIUS TO SUBSCRIBE" appears.
- It may take a little time to start receiving after you selected the SIRIUS source.
- If the signal receiving fails, "Acquiring Signal" appears.

## Switching Seek Mode

Sets the seeking mode.

Press the [AUTO] button.

Each time the button is pressed the Seek mode switches as shown below.

<b>Display</b>	<b>Operation</b>
"Channel"	Normal manual seeking control.
"Preset"	Search in order of the channels in the Preset memory.

## Channel/Category Search

Selecting the channel and category you want to receive.

### 1 Select the key function section

Press the [NEXT] button.

Repeatedly press the button until "CH+/" "CH-/" "CS+/" "CS-" is displayed above the [2] — [5] button.

### 2 Select the item for adjustment

Press the desired [2] — [5] button.

Each time the button is pressed the items that can be adjusted switch as shown below.

<b>Adjustment Item</b>	<b>Button</b>	<b>Display</b>
Search down in category	[2]	"CS-"
Search up in category	[3]	"CS+"
Search down for channel in selected category	[4]	"CH-"
Search up for channel in selected category	[5]	"CH+"



You cannot operate this unit until all the Category information is acquired.

## Sirius tuner control features

### Direct Access Tuning (Function of remote)

Entering the channel and tuning.

#### 1 Enter Direct Access Tuning mode

Press the [DIRECT] button on the remote.

#### 2 Enter the channel

Press the number buttons.

#### 3 Do Channel Search

Press the [◀◀] or [▶▶] button.

### Canceling Direct Access Tuning

Press the [DIRECT] button on the remote.



- If you make no button operation for 10 seconds, the Direct Access Tuning mode is automatically canceled.
- You can set up to Channel number 223.
- If there is no signal in the input Channel, "NO CH" appears.
- If you cannot receive any signal in the input Channel due to a bad condition on radio wave or another problem, "Acquiring Signal" appears.

### Selecting the Preset Band

Press the [FM] button.

Each time the button is pressed the preset band switches between the SR1,SR2,SR3 and SR4.

### Channel Preset Memory

Putting the channel in the memory.

#### 1 Select the preset band

Press the [FM] button.

#### 2 Select the channel to put in the memory

Press the [◀◀] or [▶▶] button.

#### 3 Select the key function section

Press the [NEXT] button.

Hold down on the [2] — [5] button until the function item is not displayed above the button.

Refer to <Notes on Multi-function Key System> (page 8).

#### 4 Put the channel in the memory

Press the desired [1] — [6] button for at least 2 seconds.

The preset number display blinks 1 time.

On each band, 1 channel can be put in the memory on each [1] — [6] button.



Only the channel number is stored. Category information is not stored.

### Preset Tuning

Calling up the channels in the memory.

#### 1 Select the preset band

Press the [FM] button.

#### 2 Select the key function section

Press the [NEXT] button.

Hold down on the button until the function item is not displayed above the [2] — [5] button.

#### 3 Call up the channel

Press the desired [1] — [6] button.

### Channel Scan

Every receivable Channel is checked for 10 seconds.

#### 1 Start Channel Scan

Press the [AUTO] button for at least 2 seconds.

The channel number display blinks.

## Menu system

### 2 Release it when the song you want to listen to is received

Press the [AUTO] button for at least 2 seconds.

### Text Scroll for Sirius tuner source

Scrolls the displayed channel name and other items.

Press the [SCRL] button.

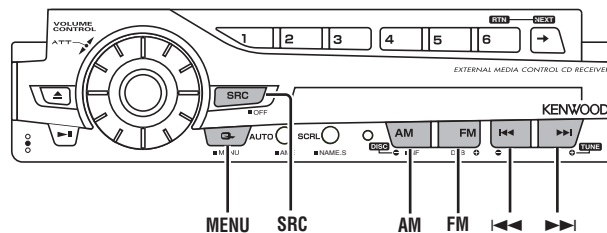

Menu display

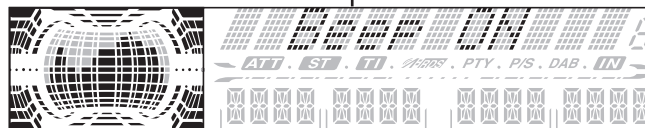

## Menu system

### Menu System

Setting during operation beep sound etc. functions.

The Menu system basic operation method is explained here. The reference for the Menu items and their setting content is after this operation explanation.

#### 1 Enter Menu mode

Press the [MENU] button for at least 1 second.  
"MENU" is displayed.

#### 2 Select the menu item

Press the [FM] or [AM] button.

Example: When you want to set the beep sound select the "Beep" display.

#### 3 Set the menu item

Press the [◀◀] or [▶▶] button.

Example: When "Beep" is selected, each time the button is pressed it switches "Beep ON" or "Beep OFF". Select 1 of them as the setting.

You can continue by returning to step 2 and setting other items.

#### 4 Exit Menu mode

Press the [MENU] button.



When other items that are applicable to the basic operation method above are displayed afterwards their setting content chart is entered. (Normally the uppermost setting in the chart is the original setting.)

Also, the explanation for items that aren't applicable (<Manual Clock Adjustment>etc.) are entered step by step.



When the Security Code function is activated, the code can't be changed and the function can't be released.

Note, the Security Code can be set as the 4 digit number of your choice.

#### 1 Enter Standby

Press the [SRC] button.

Select the "ALL OFF" display.

#### 2 Enter Menu mode

Press the [MENU] button for at least 1 second.

When "MENU" is displayed, "Security" is displayed.

#### 3 Enter Security Code mode

Press the [◀◀] or [▶▶] button for at least 1 second.

When "ENTER" is displayed, "CODE" is displayed.

#### 4 Select the digits to enter

Press the [◀◀] or [▶▶] button.

#### 5 Select the Security Code numbers

Press the [FM] or [AM] button.

#### 6 Repeat steps 4 and 5, and complete the Security Code.

#### 7 Confirm the Security Code

Press the [▶▶] button for at least 3 seconds.

When "RE-ENTER" is displayed, "CODE" is displayed.

#### 8 Do the step 4 through 7 operation, and reenter the Security Code.

"APPROVED" is displayed.

The Security Code function activates.



When the wrong Code is entered in steps 4 through 6, repeat from step 4.

**Press the Reset button and when it's removed from the battery power source**

#### 1 Turn the power ON.

#### 2 Do the step 4 through 7 operation, and enter the Security

### Security Code

#### <In Standby mode>

Because authorization by the Security Code is required when it's removed from the vehicle, personalizing this unit is by using the Security Code is a help in preventing theft.



Code.

"APPROVED" is displayed.

The unit can be used.

## Touch Sensor Tone

Setting the operation check sound (beep sound) ON/OFF.

Display	Setting
"Beep ON"	Beep is heard.
"Beep OFF"	Beep canceled.

## Manual Clock Adjustment

### 1 Select Clock Adjustment mode

Press the [FM] or [AM] button.

Select the "Clock Adjust" display.

### 2 Enter Clock Adjust mode

Press the [◀◀] or [▶▶] button for at least 1 second.

The clock display blinks.

### 3 Adjust the hours

Press the [FM] or [AM] button.

#### Adjust the minutes

Press the [◀◀] or [▶▶] button.

### 4 Exit Clock adjustment mode

Press the [MENU] button.

## DSI (Disabled System Indicator)

A red indicator will blink on the unit after the faceplate is removed, warning potential thieves.

Display	Setting
"DSI ON"	LED flashes.
"DSI OFF"	LED OFF.

## Selectable Illumination

Selecting the button illumination color as green or red.

Display	Setting
"Button Red"	The illumination color is red.
"Button Green"	The illumination color is green.

## Contrast Adjustment

Adjusting the display contrast.

Display and Setting
"Contrast 0"
:
"Contrast 5" (Original setting)
:
"Contrast 10"

## Menu system

### Dimmer

Dimming this unit's display automatically when the vehicle light switch is turned ON.

Display	Setting
"Dimmer ON"	The display dims.
"Dimmer OFF"	The display doesn't dim.

### OFF Wait Time Setting

Setting the time until the faceplate hide operation starts after the power is turned OFF.

The faceplate can be removed only during the set time period.

#### Display and Setting

"Off Wait 0s"	
⋮	
"Off Wait 3s" (Original setting)	
⋮	
"Off Wait 25s"	

### Eject angle setting

<In Standby mode>

This function sets the opening and closing operation of a panel when a disc is inserted and when it is ejected.

Display	Setting
"Ejct Ang Slp"	Opens and closes the panel while maintaining the angle of the control panel to the set angle.
"Ejct Ang Lvl"	Opens and closes the panel after setting the angle of the control panel to the horizontal position.

Function of the KDC-X769

### System Q Setting

Setting display/don't display for the System Q factors (Bass center frequency, Bass Q factor, Bass extend, Middle center frequency, Middle Q factor, and Treble center frequency) in Audio control.

Display	Setting
"System Q ON"	The System Q factors are displayed.
"System Q OFF"	The System Q factors aren't displayed.

Function of the KDC-V7022/KDC-722

### Switching preout

<In Standby mode>

Switching the preout between the rear and non-fading. (In non-fading it outputs without effect from the fader control.)

Display	Setting
"SWPRE Rear"	Rear preout.
"SWPRE N-Fad"	Non-fading preout.

### Built-in Amp Mute Setting

<In Standby mode>

Toggles ON or OFF the mute control on the built-in amplifier. Turning ON this control enhances the preout quality.

Display	Setting
"AMP Mute OFF"	The built-in amplifier activates.
"AMP Mute ON"	The built-in amplifier deactivates.

Function of the KDC-X769

**B.M.S. (Bass Management System)**

Adjust the bass boost level of the external amplifier using the main unit.

Display	Setting
"AMP BASS FLT"	Bass boost level is flat.
"AMP BASS +6"	Bass boost level is low (+6dB).
"AMP BASS +12"	Bass boost level is mid (+12dB).
"AMP BASS +18"	Bass boost level is high (+18dB).

- Refer to the catalog or instruction manual for power amplifiers that can be controlled from this unit.
- For amplifiers there are the model that can be set from Flat to +18 dB, and the model that can be set from Flat to +12 dB. When an amplifier that can only be set to +12 is connected to the unit, "AMP BASS +18" won't work correctly even if it's selected.

Function of the KDC-X769

**B.M.S. Frequency Offset**

Setting the central frequency boosted by B.M.S.

Display	Setting
"AMP Freq NML"	Boost with the normal central frequency
"AMP Freq Low"	Drop the normal central frequency 20%

**Sirius ID [ESN] display <In Sirius tuner source>**

Displaying the Sirius ID(Electronic Serial Number) display

**Display**

"ESN = \*\*\*\*\*"



**Serial & Sirius ID [ESN]**

It is especially important to retain the unit serial number and the electronic Sirius Identification number for service activation and potential future service changes.

**CRSC (Clean Reception System Circuit)**

**<In FM reception>**

Temporarily have reception switched from stereo to mono to reduce multi-path noise when listening to the FM station.

**Display**

"CRSC ON"

"CRSC OFF"

**Setting**

The CRSC is ON.

The CRSC is OFF.



Strong electrical fields (such as from power lines) may cause unstable sound quality when CRSC is turned ON. In such a situation, turn it OFF.

## Menu system

### Text Scroll

Setting the displayed text scroll.

Display	Setting
"Scroll Auto"	Repeats scroll.
"Scroll MANU"	Scrolls when the display changes.



The text scrolled is shown below.

- CD text
- Folder name/ File name/ Song title/ Artist name/ Album name
- MD title
- Text for the Sirius tuner source, including Channel name, etc.



Setting "CD READ 2" cannot play MP3.  
Some music CDs may not be played back even in the "CD READ 2" mode.

### Function of the KDC-V7022/KDC-X769

### Built-in Auxiliary input Setting

Set the Built-in Auxiliary Input function.

Display	Setting
"AUX OFF"	When selecting the source there's no Auxiliary Input.
"AUX ON"	When selecting the source there's Auxiliary Input.

### Function of the KDC-MP822

### CD Read Setting <In Standby mode>

When there is a problem on playing a CD with special format, this setting play the CD by force.

Display	Setting
"CD READ 1"	Play CD and MP3.
"CD READ 2"	Play CD by force.

## Basic Operations of remote

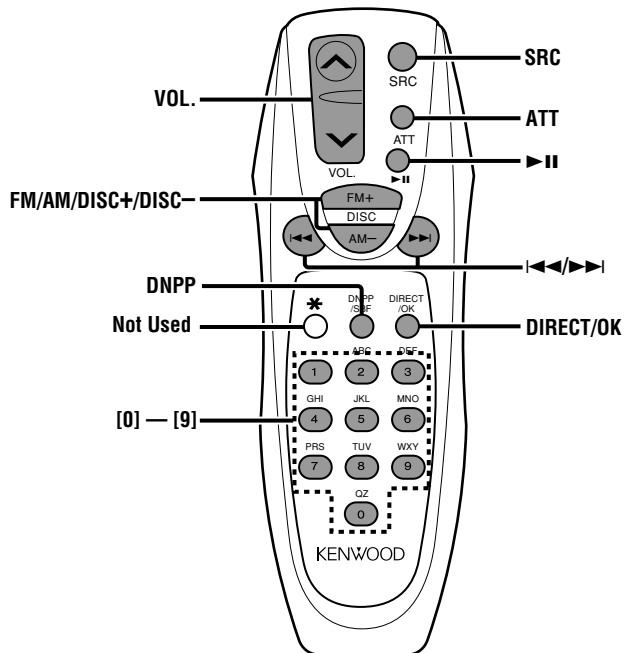

## Loading and Replacing the battery

Use two "AA"-size batteries.

Slide the cover while pressing downwards to remove it as illustrated.

Insert the batteries with the + and - poles aligned properly, following the illustration inside the case.

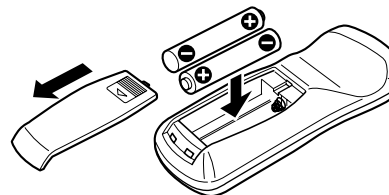

### ▲WARNING

Store unused batteries out of the reach of children. Contact a doctor immediately if the battery is accidentally swallowed.



Do not set the remote on hot places such as above the dashboard.

## Basic operations

### [VOL.] buttons

Adjusting the volume.

### [SRC] button

Each time the button is pressed the source switches.

For the source switching order refer to <Selecting the Source> (page 10).

### [ATT] button

Turning the volume down quickly.

When it is pressed again it returns to the previous level.

## Basic Operations of remote

### In Tuner source

#### [FM]/ [AM] buttons

Select the band.

Each time the [FM] button is pressed it switches between the FM1, FM2, and FM3 bands.

#### [◀◀]/ [▶▶] buttons

Tune up or down band.

#### [0] — [9] buttons

Press buttons [1] — [6] to recall preset stations.

#### [DIRECT] button

Enters and cancels the <Direct Access Tuning> (page 22) mode.

### In Disc source

#### [◀◀]/ [▶▶] buttons

Doing track/file forward and backward.

#### [DISC+]/ [DISC-] buttons

Doing disc/folder forward and backward.

#### [▶II] button

Each time the button is pressed the song pauses and plays.

#### [DNPP]/ [OK] button

Enters and cancels the <DNPP (Disc Name Preset Play)> (page 28) mode.

#### [0] — [9] buttons

When in <Direct Track/File Search> (page 25) and <Direct Disc Search> (page 25), enter the track/file/disc number.

### In Sirius tuner source

#### [FM] button

Select the preset band.

#### [◀◀]/ [▶▶] buttons

Search up or down channel.

#### [0] — [9] buttons

Press buttons [1] — [6] to recall preset channels.

#### [DIRECT] button

Enters and cancels the <Direct Access Tuning> (page 30) mode.

## Accessories

### External view

..... Number of items

①

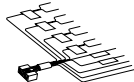

.....1

②

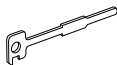

.....2

③



.....4

### External view

..... Number of items

④



.....4

⑤



.....2



Do not use any accessories other than those provided with your unit. If you use other accessories, you may damage the unit.

### ▲WARNING

If you connect the ignition wire (red) and the battery wire (yellow) to the car chassis (ground), you may cause a short circuit, that in turn may start a fire. Always connect those wires to the power source running through the fuse box.

### ▲CAUTION

- If your car's ignition does not have an ACC position, connect the ignition wires to a power source that can be turned on and off with the ignition key. If you connect the ignition wire to a power source with a constant voltage supply, as with battery wires, the battery may die.
- If the console has a lid, make sure to install the unit so that the faceplate will not hit the lid when closing and opening.
- If the fuse blows, first make sure the wires aren't touching to cause a short circuit, then replace the old fuse with one with the same rating.
- Insulate unconnected wires with vinyl tape or other similar material. To prevent a short circuit, do not remove the caps on the ends of the unconnected wires or the terminals.
- Connect the speaker wires correctly to the terminals to which they correspond. The unit may be damaged or fail to work if you share the ⊖ wires or ground them to any metal part in the car.
- When only two speakers are being connected to the system, connect the connectors either to both the front output terminals or to both the rear output terminals (do not mix front and rear). For example, if you connect the ⊕ connector of the left speaker to a front output terminal, do not connect the ⊖ connector to a rear output terminal.
- After the unit is installed, check whether the brake lamps, blinkers, wipers, etc. on the car are working properly.
- Mount the unit so that the mounting angle is 30° or less.

## Installation Procedure

1. To prevent a short circuit, remove the key from the ignition and disconnect the ⊖ battery.
2. Make the proper input and output wire connections for each unit.
3. Connect the speaker wires of the wiring harness.
4. Connect the wiring harness wires in the following order: ground, battery, ignition.
5. Connect the wiring harness connector to the unit.
6. Install the unit in your car.
7. Reconnect the ⊖ battery.
8. Turn the vehicle's ignition key on and open the panel.
9. Press the reset button.

## Connecting Wires to Terminals

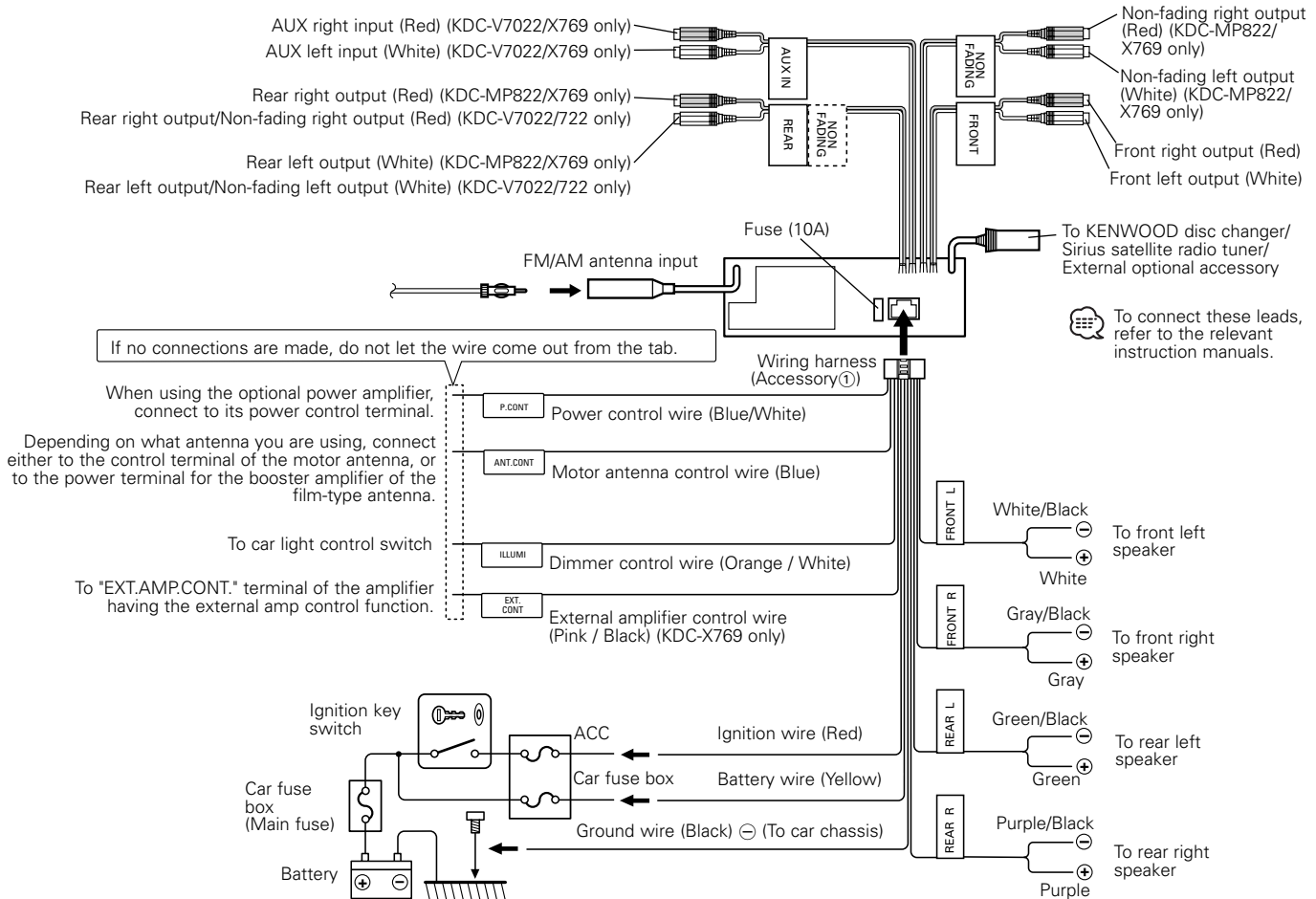



## Installation (non-Japanese cars)

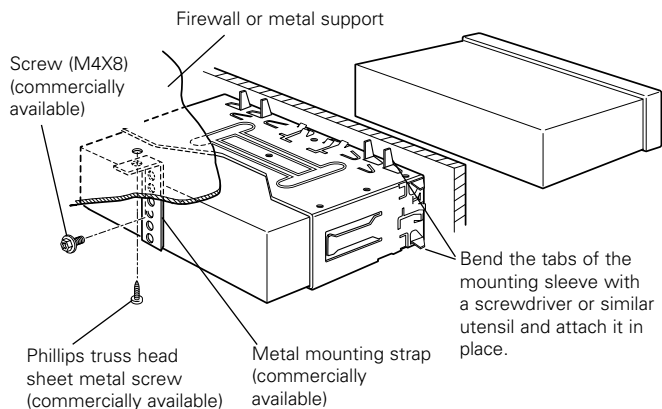

 Make sure that the unit is installed securely in place. If the unit is unstable, it may malfunction (for example, the sound may skip).

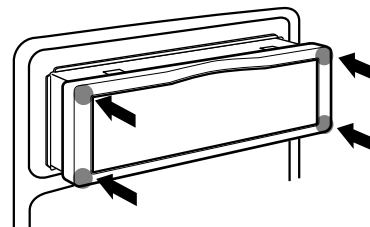

- To attach this unit, make sure the front of the control panel faces you and fit it into the mounting sleeve by pressing the four corners of the hard rubber frame at the same time. Do not apply strong pressure to other sections than the corners; otherwise troubles such as the impossibility of opening or closing the panel may result.
- The hollow at the center of the rubber frame is designed to make it easier to remove discs. If you do not want the hollow to be visible, mount the rubber frame in the opposite direction (with the flat side at the top instead of the bottom).

## Installation (Japanese-cars)

After aligning the factory-installed radio bracket, tighten the screws.

### For Toyota Car



Accessory④  
for Toyota car

### For Nissan Car

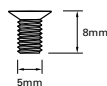

Accessory③  
for Nissan car



Damage to the unit will result from using screws other than those provided.

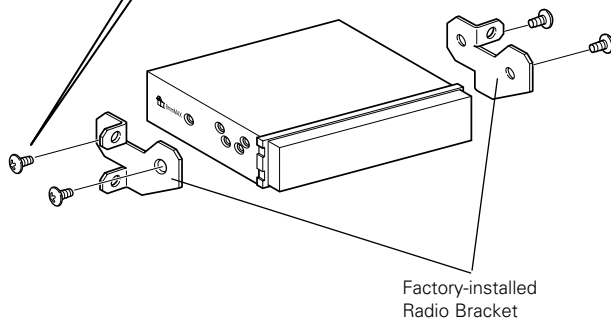

## Removing the Unit

### ■ Removing the hard rubber frame

- Engage the catch pins on the removal tool and remove the two locks on the upper level. Upper the frame and pull it forward as shown in the figure.

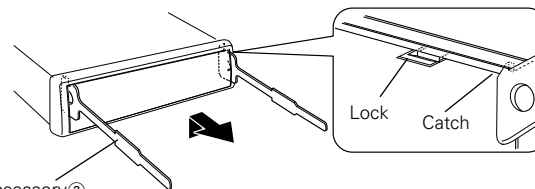

Accessory②  
Removal tool

- When the upper level is removed, remove the lower two locations.

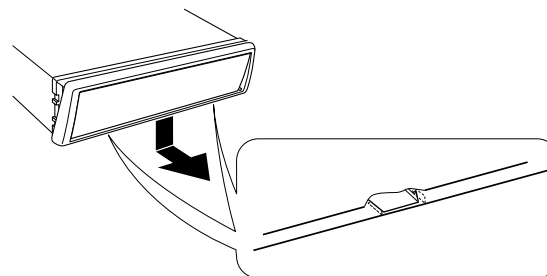

The frame can be removed from the bottom side in the same manner.

## ■ Removing the Unit

- 1 Refer to the section <Removing the hard rubber frame> and then remove the hard rubber frame.
- 2 Remove the screw (M4 × 8) on the back side.
- 3 Insert the two removal tools deeply into the slots on each side, as shown.

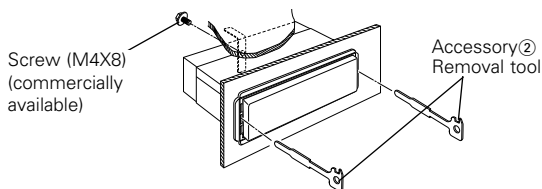

- 4 Lower the removal tool toward the bottom, and pull out the unit halfway while pressing towards the inside.

 Be careful to avoid injury from the catch pins on the removal tool.

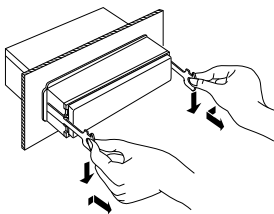

- 5 Pull the unit all the way out with your hands, being careful not to drop it.

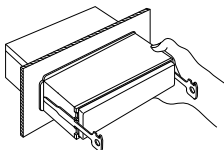

## Locking the Backpanel to the unit

- 1 Refer to the Removing the Backpanel function of the section on <Theft Deterrent Panel> (page 18) and remove the Backpanel.
- 2 Insert the panel lock screws into the holes at the sides of the panel.

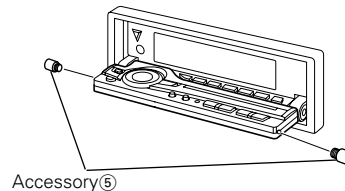

- 3 Reattach the Backpanel.

 Never insert the panel lock screws (M2 X 1.5 mm) in any other screw holes than the one specified. If you insert them in another hole, it will contract and may cause damage to the mechanical parts inside the unit.

## Troubleshooting Guide

**What might seem to be a malfunction in your unit may just be the result of slight misoperation or miswiring. Before calling service, first check the following table for possible problems.**

### General

#### ? The power does not turn ON.

- ✓ The fuse has blown.
  - ☞ After checking for short circuits in the wires, replace the fuse with one with the same rating.

#### ? There's a source you can't switch.

- ✓ There's no media inserted.
  - ☞ Set the media you want to listen to. If there's no media in this unit, you can't switch to each source.
- ✓ The Disc changer isn't connected.
  - ☞ Connect the Disc changer. If the Disc changer isn't connected to it's input terminal, You can't switch to an external disc source.

#### ? The memory is erased when the ignition is turned OFF.

- ✓ The ignition and battery wire are incorrectly connected.
  - ☞ Connect the wire correctly, referring to the section on <Connecting Wires to Terminals>.

#### ? There's no loudness effect.

- ✓ You're using Non-fading preout.
  - ☞ Loudness has no effect in Non-fading preout.

#### ? The Non-fading output can't be turned ON or OFF.

- ✓ The <Switching preout> (page 34) is set is set on Rear preout.
  - ☞ Change it to Non-fading preout.

#### ? Even if Loudness is turned ON, high-pitched tone isn't compensated for.

- ✓ Tuner source is selected.
  - ☞ High-pitched tone isn't compensated for when in Tuner source.

#### ? The Bass center frequency, Bass quality factor, Bass extend, Middle center frequency, Middle quality factor, and Treble center frequency can't be adjusted.

- ✓ The <System Q Setting> (page 34) is set OFF.
  - ☞ Set it ON.

#### ? No sound can be heard, or the volume is low.

- ✓ The fader or balance settings are set all the way to one side.
  - ☞ Center the fader and balance settings.
- ✓ The input/output wires or wiring harness are connected incorrectly.
  - ☞ Reconnect the input/output wires or the wiring harness correctly. See the section on <Connecting Wires to Terminals>.
- ✓ The values of Volume offset are low.
  - ☞ Turn up the Volume offset, referring to the section on <Audio control> (page12).
- ✓ The <Built-in Amp Mute Setting> (page 34) is ON.
  - ☞ Turn it OFF.

#### ? The sound quality is poor or distorted.

- ✓ One of the speaker wires is being pinched by a screw in the car.
  - ☞ Check the speaker wiring.
- ✓ The speakers are not wired correctly.
  - ☞ Reconnect the speaker wires so that each output terminal is connected to a different speaker.

#### ? Non-fading output, Non-fading Low Pass Filter and Non-fading setting can't be done.

- ✓ The <Switching preout> (page 34) is set on Rear preout.
  - ☞ Set it on Non-fading preout.
- ✓ The <Non-fading output> (page 17) is OFF.
  - ☞ Turn it ON.
- ✓ The <Dual zone system> (page 20) is ON.
  - ☞ Turn it OFF.

#### ? There's no Front High Pass Filter and Rear High Pass Filter effect.

- ✓ The Non-fading preout is being used.
  - ☞ There's no effect in Non-fading preout.

#### ? The Touch Sensor Tone doesn't sound.

- ✓ The preout jack is being used.
  - ☞ The Touch Sensor Tone can't be output from the preout jack.

#### ? The Dimmer function doesn't work.

- ✓ The Dimmer wire isn't connected correctly.
  - ☞ Check the Dimmer wire connection.

**? The display color changes subtly.**

- ✓ This is because the temperature is different than the temperature when the setting was done.
    - ☞ The display color condition changes subtly according to the ambient temperature.
- 

**? The panel is not hidden even when the power is turned off.**

- ✓ The protection function for preventing fingers or other things from getting caught in between the panel and this unit has been activated.
    - ☞ Turn off the power again.
- 

## Tuner source

**? Radio reception is poor.**

- ✓ The car antenna is not extended.
    - ☞ Pull the antenna out all the way.
  - ✓ The antenna control wire is not connected.
    - ☞ Connect the wire correctly, referring to the section on <Connecting Wires to Terminals>.
- 

**? The desired frequency can't be entered with the Direct Access Tuning.**

- ✓ A station that can't be received is being entered.
    - ☞ Enter a station that can be received.
  - ✓ You're trying to enter a frequency with a 0.01 MHz unit.
    - ☞ What can be designated in the FM band is to 0.1 MHz.
- 

## Disc source

**? "AUX1" is displayed without achieving External disc control mode.**

- ✓ Unsupported disc changer is connected.
    - ☞ Use the disc changer mentioned in the IMPORTANT INFORMATION of the section on <Safety precautions> (page 4).
- 

**? The specified disc does not play, but another one plays instead.**

- ✓ The specified CD is quite dirty.
    - ☞ Clean the CD.
  - ✓ The disc is loaded in a different slot from that specified.
    - ☞ Eject the disc magazine and check the number for the specified disc.
  - ✓ The disc is severely scratched.
    - ☞ Try another disc instead.
- 

**? A CD ejects as soon as it is loaded.**

- ✓ The CD is quite dirty.
    - ☞ Clean the CD, referring to the CD cleaning of the section on <About CDs> (page 9).
- 

**? Can't remove disc.**

- ✓ The cause is that more than 10 minutes has elapsed since the vehicle ACC switch was turned OFF.
    - ☞ The disc can only be removed within 10 minutes of the ACC switch being turned OFF. If more than 10 minutes has elapsed, turn the ACC switch ON again and press the Eject button.
- 

**? The disc won't insert.**

- ✓ There's already another disc inserted.
    - ☞ Press the [▲] button and remove the disc.
- 

**? Direct Search can't be done.**

- ✓ Another function is ON.
    - ☞ Turn Random Play or other functions OFF.
- 

**? Track Search can't be done.**

- ✓ For the discs/folders first or last song.
    - ☞ For each disc/folder, Track Search can't be done in the backward direction for the first song or in the forward direction for the last song.
- 

## MP3 source

**? Cannot play an MP3.**

- ✓ The media is scratched or dirty.
    - ☞ Clean the media, referring to the CD cleaning of the section on <About CDs> (page 9).
- 

**? The sound skips when an MP3 is being played.**

- ✓ The media is scratched or dirty.
    - ☞ Clean the media, referring to the CD cleaning of the section on <About CDs> (page 9).
  - ✓ The recording condition is bad.
    - ☞ Record the media again or use another media.
- 

**? The MP3 track time isn't displayed correctly.**

- ✓ --
    - ☞ There are times when it isn't displayed correctly according to the MP3 recording conditions.
-

## Troubleshooting Guide

### If the following situations, consult your nearest service center:

Even though the disc changer is connected, the Disc Changer source is not ON, with "AUX1" showing in the display during the Changer Mode.

### The messages shown below display your systems condition.

EJECT:	No disc magazine has been loaded in the changer. The disc magazine is not completely loaded. ⇨ Load the disc magazine properly. No CD in the unit. ⇨ Insert the CD.
No Disc:	No disc has been loaded in the disc magazine. ⇨ Load a disc into the disc magazine.
TOC Error:	No disc has been loaded in the disc magazine. ⇨ Load a disc into the disc magazine. The CD is quite dirty. The CD is upside-down. The CD is scratched a lot. ⇨ Clean the CD and load it correctly.
E-05:	The CD is upside-down. ⇨ Load the CD correctly.
Blank Disc:	Nothing has been recorded on the MD.
No Track:	No tracks are recorded on the MD, although it has a title.
E-15:	Media was played that doesn't have data recorded that the unit can play. ⇨ Use media that has data recorded that the unit can play.
No Panel:	The faceplate of the slave unit being connected to this unit has been removed. ⇨ Replace it.
E-77:	The unit is malfunctioning for some reason. ⇨ Press the reset button on the unit. If the "E-77" code does not disappear, consult your nearest service center.

Mecha Error:	Something is wrong with the disc magazine. Or the unit is malfunctioning for some reason. ⇨ Check the disc magazine. And then press the reset button on the unit. If the "Mecha Error" code does not disappear, consult your nearest service center.
Hold Error:	The protective circuit in the unit activates when the temperature inside the automatic disc changer exceeds 60°C (140°F), stopping all operation. ⇨ Cool down the unit by opening the windows or turning on the air conditioner. As the temperature falls below 60°C (140°F), the disc will start playing again.
NO NAME:	Attempted to display DNPS during the CD play having no disc names preset.
Load:	Discs are being exchanged in the Disc changer.
Reading:	The unit is reading the data on the disc.
NO ACCESS:	After setting it in the Disc Changer, DNPP was done without having it been played at least 1 time.
IN (Blink):	The CD player section is not operating properly. ⇨ Reinsert the CD. If the CD cannot be ejected or the display continues to flash even when the CD has been properly reinserted, please switch off the power and consult your nearest service center.

## Specifications

### Specifications subject to change without notice.

#### FM tuner section

Frequency range (200 kHz space) .....	87.9 MHz – 107.9 MHz
Usable sensitivity (S/N = 30dB) .....	9.3dBf (0.8 $\mu$ V /75 $\Omega$ )
Quieting Sensitivity (S/N = 50dB) .....	15.2dBf (1.6 $\mu$ V /75 $\Omega$ )
Frequency response ( $\pm$ 3 dB) .....	30 Hz – 15 kHz
Signal to Noise ratio (MONO) .....	70 dB
Selectivity ( $\pm$ 400 kHz) .....	$\geq$ 80 dB
Stereo separation (1 kHz) .....	40 dB

#### AM tuner section

Frequency range (10 kHz space) .....	530 kHz – 1700 kHz
Usable sensitivity (S/N = 20dB) .....	28 dB $\mu$ (25 $\mu$ V)

#### CD player section

Laser diode .....	GaAlAs ( $\lambda$ =780 nm)
Digital filter (D/A) .....	8 Times Over Sampling
D/A Converter .....	1 Bit
Spindle speed	
(KDC-MP822) .....	1000 – 400 rpm (CLV 2times)
(KDC-V7022/X769/722) .....	500 – 200 rpm (CLV)
Wow & Flutter .....	Below Measurable Limit
Frequency response ( $\pm$ 1 dB) .....	10 Hz – 20 kHz
Total harmonic distortion (1 kHz) .....	0.01 %
Signal to Noise ratio (1 kHz) .....	105 dB
Dynamic range .....	93 dB
Channel separation .....	95 dB
MP3 decode (KDC-MP822)	
.....Compliant with MPEG-1.0/2.0/2.5 Audio Layer-3	

#### Audio section

Maximum output power .....	50 W x 4
Full Bandwidth Power (at less than 1% THD) .....	22 W x 4
Tone action	
Bass : .....	100 Hz $\pm$ 10 dB
Middle : .....	1 kHz $\pm$ 10 dB
Treble : .....	10 kHz $\pm$ 10 dB
Preout level / Load (during disc play)	
(KDC-MP822/V7022/722) .....	2000 mV/10 k $\Omega$
(KDC-X769) .....	5000 mV/10 k $\Omega$
Preout impedance	
(KDC-MP822/V7022/722) .....	$\leq$ 600 $\Omega$
(KDC-X769) .....	$\leq$ 80 $\Omega$

#### Auxiliary input (KDC-V7022/X769)

Frequency response ( $\pm$ 1 dB) .....	20 Hz – 20 kHz
Input Maximum Voltage .....	1200 mV
Input Impedance .....	100 k $\Omega$

#### General

Operating voltage (11 – 16V allowable) .....	14.4 V
Current consumption .....	10 A
Installation Size (W x H x D) .....	178 x 50 x 165 mm
	7 x 1-15/16 x 6-1/2 inch
Weight .....	3.75 lbs (1.7 kg)

KENWOOD